

Product Data

Third-octave and Octave Band Pass Filter — Type 1617

USES:

In combination with suitable Measuring Amplifier

- Third-octave and octave frequency analysis of sound and vibration
- Frequency response measurements on electroacoustic transducers
- Measurement of sound transmission loss
- Measurement of vibration isolation
- Testing acoustic materials
- Constant confidence level spectrum measurements

FEATURES:

- 50 third-octave filter bands, centre frequencies from 2Hz to 160kHz
- 41 overlapping octave bands, centre frequencies from 2Hz to 20kHz

- Third-octave and octave filters to IEC 225–1966, DIN 45651 and 45 652, and ANSI S1.11–1986
- IEEE/IEC interface for remote setting of controls via digital bus
- Digital display of selected bandwidth and centre frequency setting
- Built-in A-, B-, C- and D-weighting networks
- Manual or electronic control of filter switching
- Programs for automatic selection of Measuring Amplifier averaging time
- Automatic filter scanning via Level Recorder
- Automatic control of Level and X–Y Recorders
- Selectable scan start frequency, reduces overall time for analysis
- Input overload warning

Third-octave and Octave Band Pass Filter Type 1617 is used in instrumentation systems for measurement and recording of the frequency spectra of sound, vibration, and electroacoustic signals. The Type 1617 incorporates electronic filter switching and digital indication of the selected filter.

The Type 1617 operates with frequency variable filters which can be electronically switched to provide third-octave or full-octave bandwidths. The frequency range from 2Hz to 160kHz can be divided into 50 third-octave bands and the frequency range 2Hz to 20kHz can be divided into 41 overlapping octave bands. The instrument has built-in A-, B-, C- and D-weighting networks.

The Type 1617 has an IEEE/IEC interface for use in bus-controlled measuring set-ups.

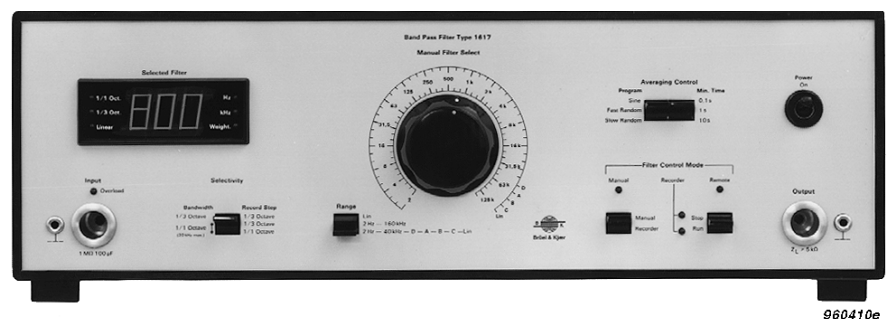

Introduction

The Type 1617 has filter band centre frequencies from 2Hz to 160kHz that can be divided into 50 third-octave bands. It has 41 overlapping octave bands covering 14 octaves from 2Hz

to 20kHz. It includes A-, B-, C- and D-weighting networks, and there is an input overload indicator lamp. Filter scanning can be controlled by a Level Recorder, and there is a built-in digital interface compatible with IEC625–1/IEEE Std. 488 to permit direct control by other instruments

and systems using these standards. A DC ramp output can control the X-axis of an X-Y Recorder, and a control circuit is included to select averaging time programs for use by the measuring instrument.

The Band Pass Filter will generally be used with one of the Measuring Amplifiers Type 2610 or 2636. Together with the Band Pass Filter and a suitable measurement transducer and a preamplifier combination, they permit a wide variety of signals to be

measured and analysed. With a Brüel & Kjær Condenser Microphone, they form a sound measurement system fulfilling IEC 651 (Type 0) for precision sound level meters.

To aid selection of a suitable measuring instrument, summarized specifications for the Brüel & Kjær Measuring Amplifiers mentioned are given in Table 1. The basic system of Band Pass Filter Type 1617 with Measuring Amplifier Type 2610 is for analysis with manual selection of av-

eraging time and automatic filter scanning controlled by a Level Recorder. Full utilization of all measurement and control possibilities, including automatic selection of averaging time is obtained using the Measuring Amplifier Type 2636. With these combinations, either a Level or X-Y Recorder may be employed for recording analyses. Alternatively, a Type 1617 and 2636 combination can be used.

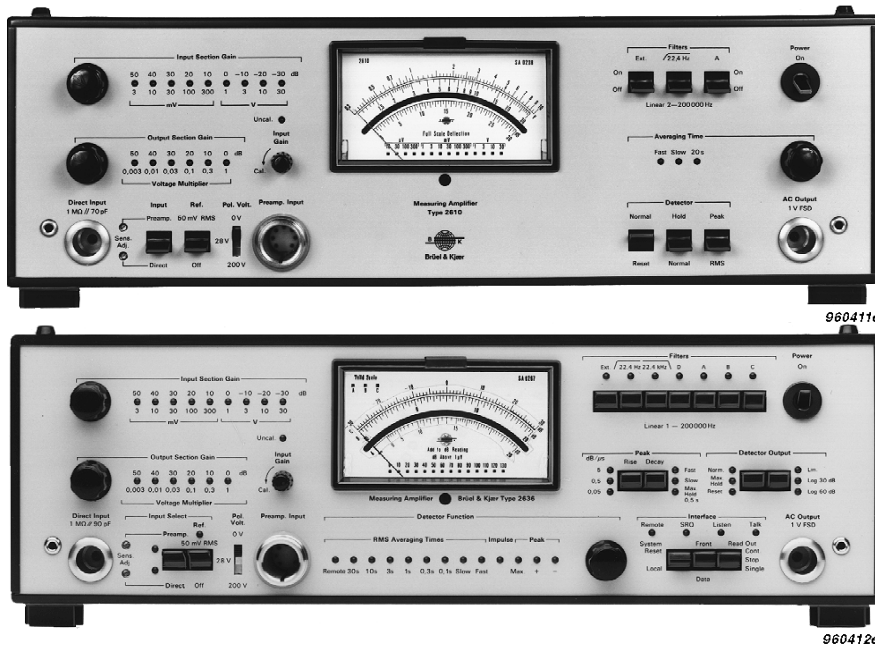

Fig 1 Measuring Amplifiers Types 2610 and 2636

Brüel & Kjær Type No.		Measuring Amplifiers	
		2610	2636
Amplifier Section	Linear Frequency Range	2 Hz to 200 kHz	1 Hz to 200 kHz
	Voltage Ranges	10 µV to 30 V FSD	
	Amplification	100 to -30 dB	
Indicating Modes	RMS	Fast - Slow 20 s Averaging	Fast - Slow 0.1 to 100 s Averaging
	Peak	1.7 dB/µs	0.05 - 0.5 - 5 dB/µs
	Impulse	-	✓
	Hold	RMS - Peak	RMS - Peak - Impulse
Inputs		Direct - Preamp.	
Outputs	AC Lin	1 and 1.6 V FSD	1 and 5 V FSD
	DC Lin	-	0 - 12 V 5 V FSD
	DC Log	60 dB 5 V FSD	
	Digital	-	IEEE/IEC Interface

* Remote control via averaging time programs of Band Pass Filter Type 1617

Table 1 B & K Measuring Amplifiers for use with Band Pass Filter Type 1617

Filter I Centre Frequency Hz	Filter II Centre Frequency Hz	1/3-octave Bandwidth at 3.7 dB Hz approx.
2		0.46
	2.5	0.50
3.15		0.73
	4	0.92
5		1.16
	6.3	1.45
8		1.83
	10	2.30
12.5		2.90
	16	3.70
20		4.60
	25	5.8
31.5		7.3
	40	9.2
50		11.6
	63	14.5
80		18.3
	100	23
125		29
	160	37
200		46
	250	58
315		73
	400	92
500		116
	630	145
800		183
	1000	230
1250		290
	1600	370
2000		460
	2500	580
3150		730
	4000	920
5000		1160
	6300	1450
8000		1830
	10000	2300
12500		2900
	16000	3700
20000		4600
25000		5800
31500		7300
40000		9200
50000		11600
63000		14500
80000		18300
100000		23000
125000		29000
160000		37000

Table 2 Filter centre frequencies in preferred series. Bold type denotes preferred series for full-octaves

Description

The Band Pass Filter is designed to operate on the signals obtained from the External Filter terminals of the Measuring Amplifiers, but any input signal up to 5V peak may be applied. Input and output are via coaxial B&K sockets on the front panel, in parallel with BNC terminals on the rear panel. Fig. 2 is a block diagram of Band Pass Filter Type 1617.

Third-Octave Band Pass Filters

The active Filter sections consist of a matched pair of variable frequency six-pole Butterworth filters which can be electronically switched to yield third-octave or full-octave bandwidths. Between them the two filters cover the frequency range from 2Hz to 160kHz centre frequencies, with each filter being switched to alternate third-octave centre frequencies in the preferred series (see Table 2).

The filter characteristics of the individual third-octave Filters used in this instrument fulfil the requirements of IEC 225-1966, DIN 45652, and ANSIS1.11-1986 (conforming to Type 1 subtype D or better). The response curve for a typical third-octave filter is shown in Fig. 3, and the top of the curve in the enlarged view in Fig. 4. The IEC, DIN and ANSI

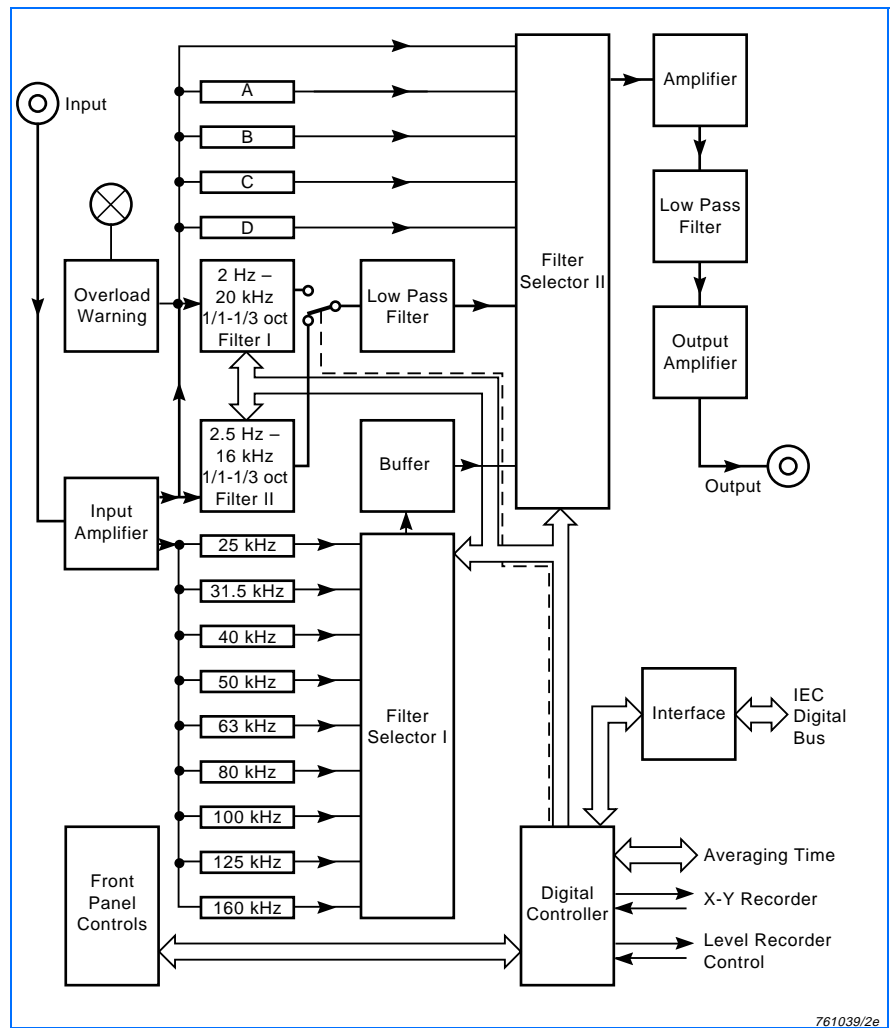

Fig. 2 Block diagram of the Band Pass Filter Type 1617

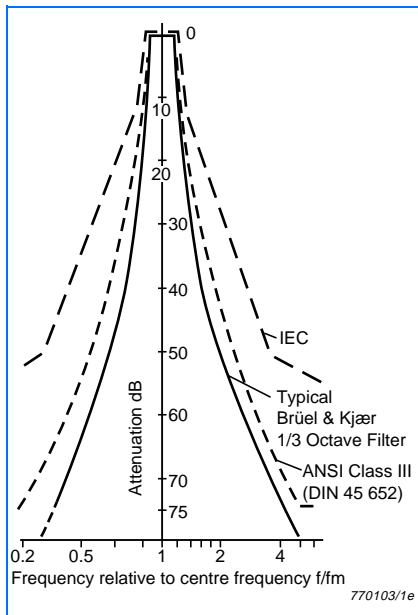

Fig. 3 Typical third-octave filter response

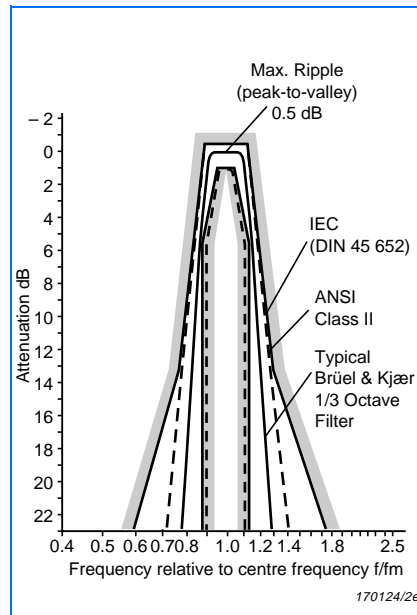

Fig. 4 Top of a third-octave filter characteristic. The filters in Type 1617 conform to ANSIS1.11-1986, Type 1 subtype D or better

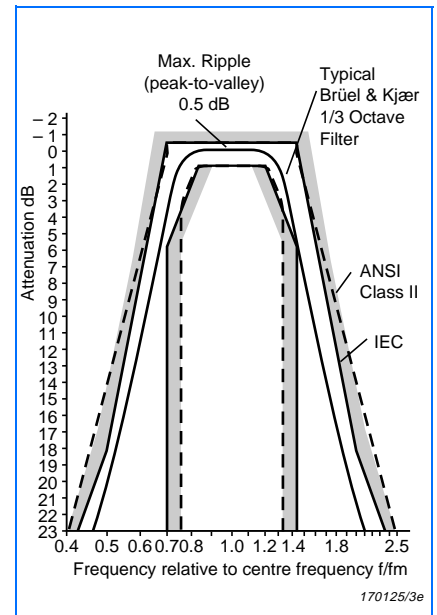

Fig. 5 Top of a typical octave filter characteristic

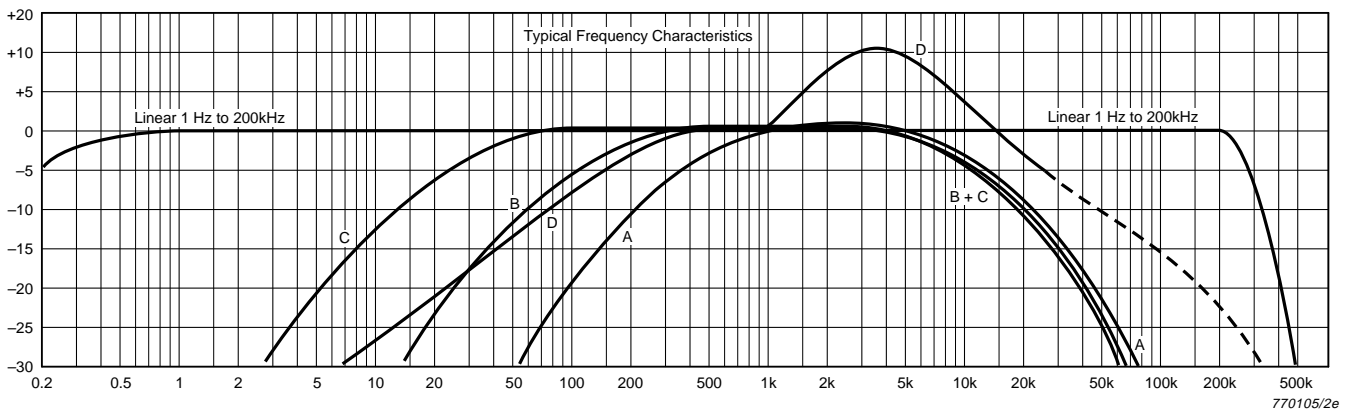

Fig.6 Weighting networks and Linear function

limitations are also indicated in both Figures. Peak-to-valley ripple in the pass band is less than 0.5dB with attenuation within ± 0.5 dB. Attenuation of frequencies outside 5 times and $1/5$ of the band centre frequency is better than 75dB.

Octave Band Pass Filters

Octave Filters are formed in the Band Pass Filter by electronically altering the components and characteristics of the Filter circuits. This arrangement gives a flat crest to the characteristic curve, and low peak-to-valley ripple. The octave Filters cover the frequency range from 2Hz to 20kHz centre frequencies, selectable at third-octaves in the preferred series. There is no provision for connection of full-octave filters at higher frequencies.

All octave Filters contained in the Type 1617 conform to IEC 225-1966, DIN 45651, and ANSIS1.11-1986 (conforming to Type 1 subtype D or better). Fig.5 shows the top of a typical octave filter characteristic, attenuation outside 8 times and $1/8$ of the band centre frequency is better than 60dB. Peak-to-valley ripple is less than 0.5dB, while attenuation in the pass band is within ± 0.5 dB.

The total integrated random (white) noise power passed by the practical octave and third-octave Filters in the Type 1617 is equal to that which would be passed by an ideal octave or third-octave filter.

Weighting Networks

In addition to linear response, Type 1617 contains A-, B- and C-weighting networks, plus the D-weighting network specified in IEC 537 for measurement of aircraft noise. The frequency responses of the four weighting networks are shown in Fig.6. Fig.6 also indicates the Linear

range 1Hz to 200kHz obtainable from the Type 1617.

Filter Selection and Scanning Ranges

Filter switching is accomplished electronically by FET switches in the Filter Selectors that are regulated by the Digital Controller acting on instructions from internal or remote control settings. Bandwidth of the Filter in use is selected by the three position Selectivity switch, giving a choice of third-octave bandwidth scanning in third-octave steps, octave bandwidth scanning in third-octave steps (with adjacent bands partially overlapping), or octave bandwidth scanning in full-octave steps.

Manual selection of any particular Filter band is made by turning the Manual Filter Selector control to the required position. There are two measuring ranges, selected by the Range switch, and hence two frequency scales. One covers the full frequency range with graduations in third-octaves with centre frequencies from 2Hz to 160kHz. The other range covers third-octave centre frequencies between 2Hz and 40kHz, and includes A-, B-, C-, D-weighting, and a linear position. A "linear" mode is available on the Range switch, which permits a Linear output to be ob-

tained at any point in a scan, without moving the Manual Filter Selector.

The centre frequency of the selected Filter Band is indicated on a half-inch digital display that also shows whether the Filter is functioning as a third-octave or as an octave filter, or whether a weighting network has been selected.

Filter Scanning

In addition to filter switching as directed by the Manual Filter Selector, the Digital Controller can operate the filter scan on the commands of an external source. The IEEE/IEC Interface permits either internal or external control in an analysis set-up, e.g with a computer.

Selection of manual or recorder control is made by the Filter Control Mode Manual/Recorder switch, while the Stop/Run switch enables the Recorder in use to be controlled from the Band Pass Filter. This control facility is blocked when "Manual" is selected, or when the Type 1617 is being controlled via the interface.

When operating in any remote control mode, the progress of the scan can be followed on the Digital Display, as the Manual Filter Selector does not rotate during an automatic scan. The Filter frequency sweep always starts from the band in which

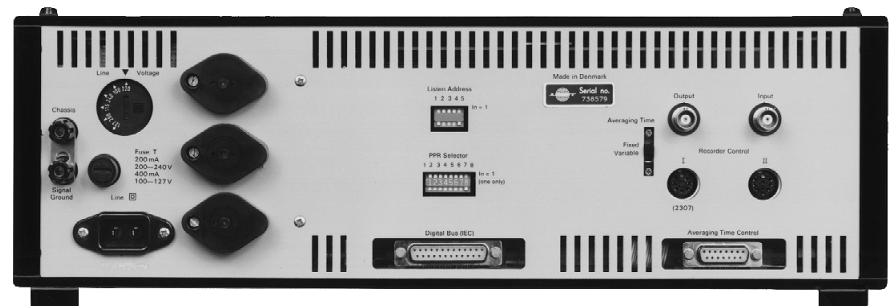

Fig.7 Rear panel of the Band Pass Filter

the Manual Filter Selector is standing, it sweeps through the selected range, and being internally actuated, it returns instantly to its starting point. This saves analysis time when low frequencies (with correspondingly long averaging times) will not be required while operating the Type 1617 with an X-Y Recorder, or under digital control via the interface bus. Similarly, when recording sound on a Level Recorder, unwanted low frequency bands can be excluded from the trace to yield a clear audio frequency spectrogram.

Averaging Time Control

This ability allows the Type 1617 to automatically step the averaging time of the Measuring Amplifier Type 2636 during the course of a frequency scan. The advantage is that the averaging time can be kept short as possible to obtain an acceptable analysis time, yet long enough to achieve a good overall confidence level and measurement accuracy at low as well as high frequencies.

The best analysis conditions are obtained when the product of the analysis bandwidth B (Hertz) and the averaging time T (seconds) is held constant throughout the scan. Accordingly the Type 1617 is equipped with a choice of averaging programs to suit analysis of "Sine", "Fast Random" and "Slow Random" signals, which help maintain the BT product as near constant as possible plus giving a constant confidence level.

However, with certain high frequency signals the use of a longer averaging may be merited. For example, where noise or vibration of slowly rotating machinery is to be investigated, the low repetition frequency can cause low frequency modulation of the measured signal and will result in inaccurate analysis (see Fig. 8) if too short an averaging time is employed. To permit accurate analysis of such signals, the averaging programs of the Type 1617 can be set not to step the Measuring Amplifier below a minimum averaging time of 0.1s, 1s or 10s. Fig. 9 indicates the particular averaging times and change-over frequencies of the different programs.

The choice of required averaging program is made using the Program and Min. Time - Averaging Control switches on the front of the Type 1617 which may be set as indicated in Table 3. Automatic selection of the programmed averaging time settings

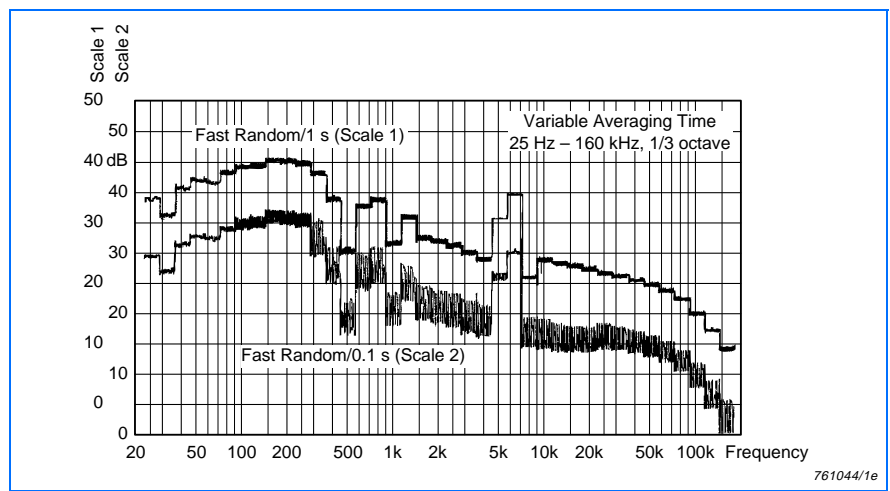

Fig 8 Conditions where longer averaging times are required for high frequency signals. The lower curve was made with too short averaging time, while for the upper curve, averaging was correct

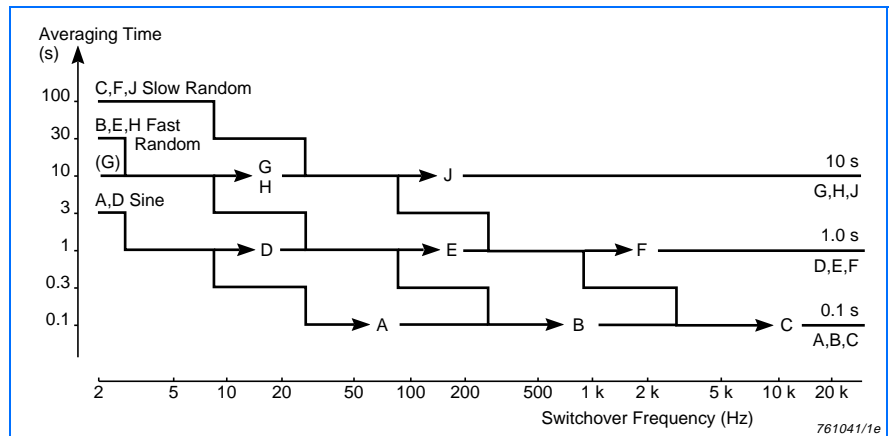

Fig 9 Averaging times and changeover frequencies

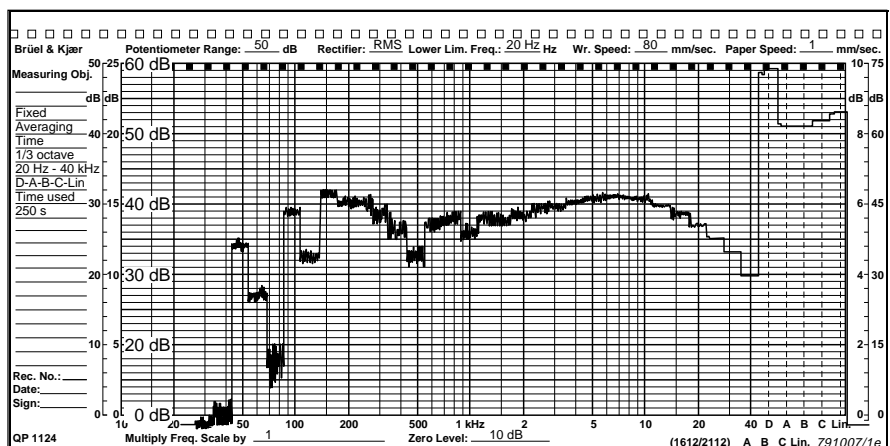

Fig 10 Frequency analysis with Level Recorder and fixed averaging time

Minimum Av. Time(s)	0.1	1.0	10
Slow Random	C	F	J
Fast Random	B	E	H
Sinus	A	D	(G)

Table 3 Selection of the required averaging time program

on the Measuring Amplifier is made via the 15-pin AVERAGING TIME CONTROL socket on the rear panel of the Type 1617 when its Averaging Time switch is set to "Variable".

With a Level or X-Y Recorder, automatic averaging time control functions as follows. The Type 1617 starts by setting the Measuring Amplifier averaging time to the value programmed for the particular frequency band selected and keeps the paper drive or X-deflection of the Recorder stationary while the Measuring Amplifier rectifies and averages the measured signal. After a period of approximately five times the programmed averaging time it sets the Measuring Amplifier to hold the analysed level while the Recorder plots the level by advancing the paper or stepping the pen to the next frequency band. The Type 1617 then stops the Recorder, steps to the next filter band and selects the programmed averaging time, thus enabling it to continue with the analysis using the same control sequence. Typical Level and X-Y recorder read-outs of analyses, employing fixed and variable averaging time control, are shown in Figs. 10, 11 and 12.

A similar control sequence is employed when using a Graphics Recorder for read out of analyses results. Either the filter centre frequencies plus the corresponding signal level in each filter band can be printed, or a fully annotated, bar-spectrum plot of analyses can be obtained. However, before a graphic plot can be printed it is necessary that the entire frequency spectrum is entered.

Digital Interface

The Type 1617 is fully programmable via a built-in IEC 625-1 standard (IEEE std. 488 compatible) digital interface for programmable instrumentation. This permits the filter bandwidth, start band, analysis range and averaging programs to be selected remotely with aid of a computer, for example, as well as permits on-line changes to be made to accommodate new events as they occur.

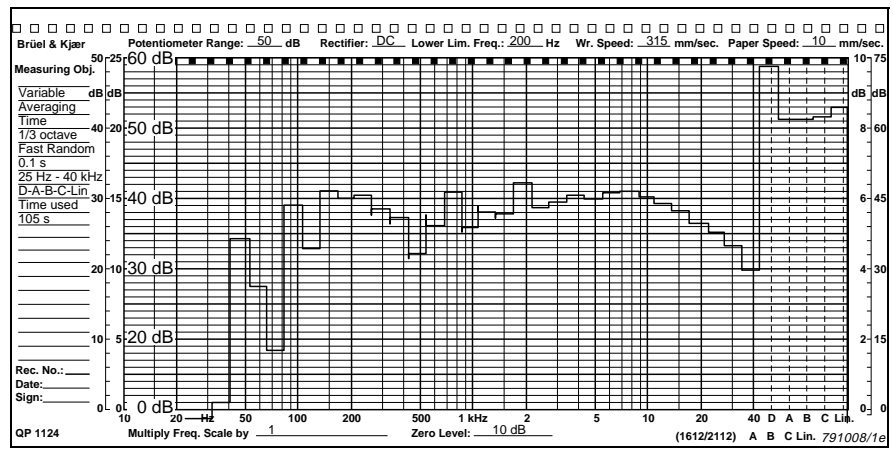

Fig. 11 Frequency analysis with Level Recorder and variable averaging times

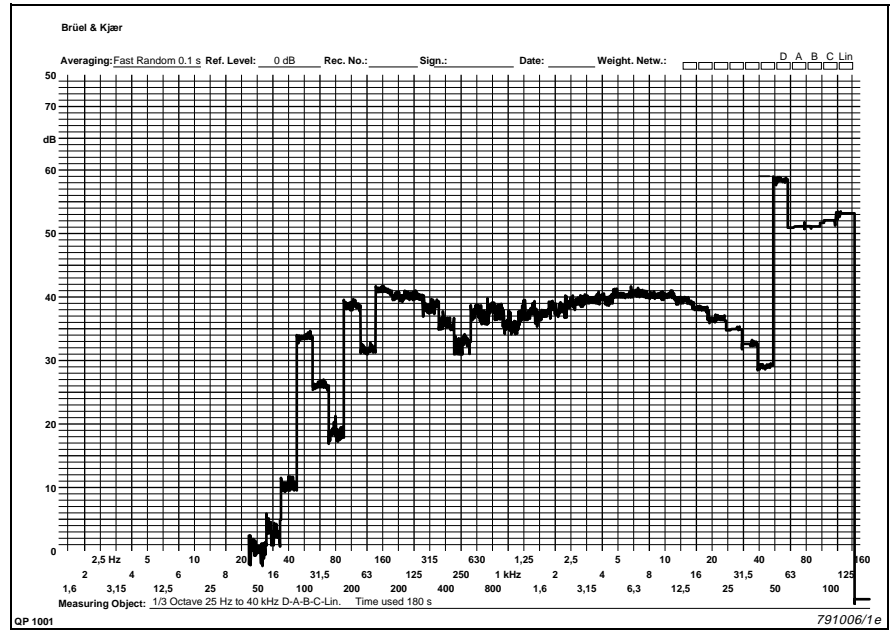

Fig. 12 Frequency analysis with X-Y Recorder and variable averaging times

Remote digital control is selected via the Listen Address switches on the rear panel of the instrument.

Example of Use

The Type 1617 may be used with Electroacoustic Test Systems which are based on Electroacoustic Test Software Type 5302 (see Fig. 13).

The ETS software is a high-level applications program which controls measurements, performs post-processing, creates displays and stores results in a flexible environment. Pop-up menus simplify the creation of test sequences. These systems are equally suited for both development and quality-control applications.

Typical measurement results include frequency response, sensitivity,

loudness rating, distortion, impedance and polarity. It is possible to check against tolerance limits resulting in a pass/fail indication. A Band Pass Filter Type 1617 should be included, to minimize the effect of background noise on acoustic measurements. During the frequency scan, the Filter tracks the generator frequency and thus suppresses noise.

The inclusion of Type 1617 in the System also allows noise analyses to be performed. The user need not specify whether sine wave signals or a spectrum should be used to measure responses; the system automatically detects whether the signal is of a random nature and optimizes the signal processing accordingly.

Furthermore, the Filter enables selective measurement of harmonic dis-

tortion. This is obtained by specifying the desired centre order. Since the Filter may be offset by up to 30 channels (10 octaves) above the generator frequency, this feature can also be used for measurement of an ensemble of higher harmonics — a test referred to as a Rub & Buzz test, which is very useful for revealing mechanical defects in dynamic transducers. It is also possible to fix the centre frequency of the filter during the frequency scan.

The Electroacoustic Test Systems are particularly well suited for testing telephones and loudspeakers, as the software controls the necessary electrical and acoustical interfaces to these measurement objects.

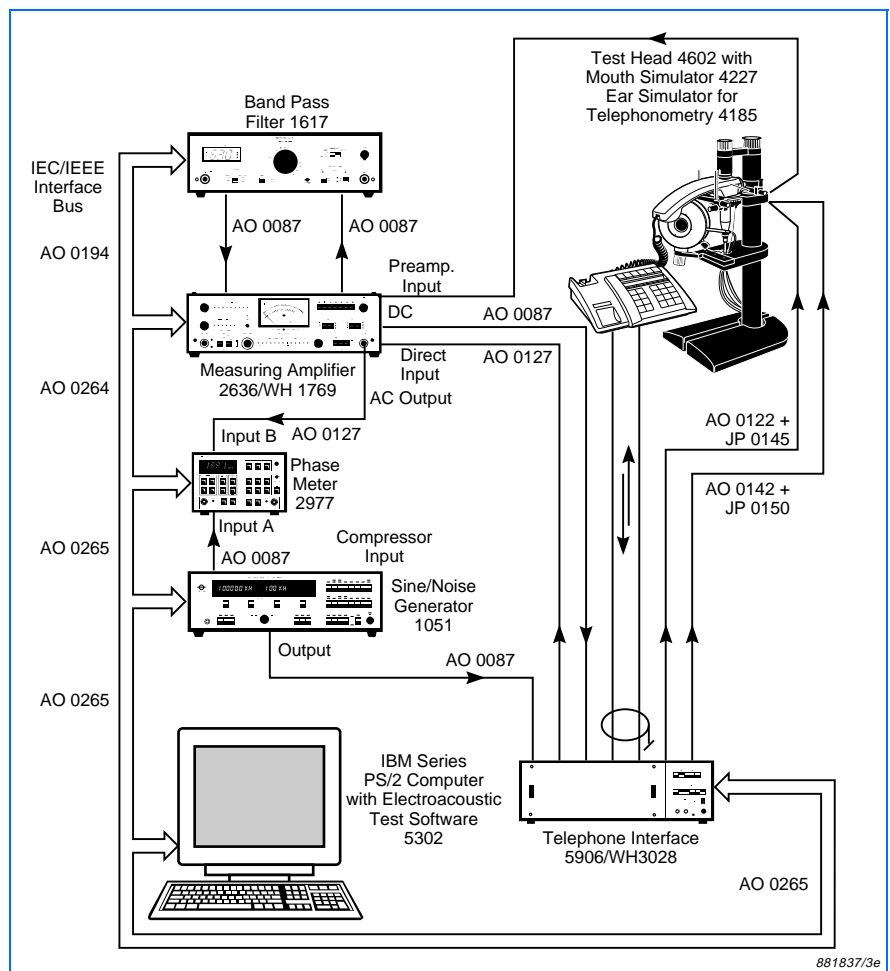

Fig. 13 Expanded Electroacoustic Test System for telephone measurements

Specifications 1617

BAND PASS FILTERS:

In accordance with IEC 225–1966, DIN 45651 and 45652 and ANSIS 1.11–1986
The total integrated random white noise power passed by the filters in these instruments is equal to that which would be passed by an ideal filter

Centre Frequencies:

1/3 oct.: 2Hz to 160kHz (50 bands)
1/1 oct.: 2Hz to 20kHz (41 overlapping bands at 1/3 octave intervals covering 14 octaves)

Attenuation Outside Pass Band:

1/3 oct.: >75dB at 5 times and 1/5 centre frequency
1/1 oct.: >60dB at 8 times and 1/8 centre frequency

Attenuation at Centre Frequency (f_m):

1/3 oct. and 1/1 oct.: 0dB \pm 0.5dB

Maximum Peak-to-Valley Ripple:

1/3 oct.: 0.5dB
1/1 oct.: 0.5dB

OVERALL SELECTIVE FREQUENCY RANGE:

1.4Hz to 180kHz

LINEAR PASS BAND:

(Available from Range switch or Manual Filter Selector):

1.6Hz to 160kHz attenuation is 0dB \pm 0.3dB
1Hz to 200kHz attenuation is 0dB \pm 0.5dB

FILTER SELECTION:

2Hz to 160kHz
2Hz to 40kHz, D, A, B, C Linear

Switching Control:

Manual: from "Manual Filter Selector"
Automatic: from a Level Recorder
Automatic: to control an X–Y Recorder (When scanning octave filters, either full-octave or third-octave stepping can be selected)
Automatic: via the IEEE/IEC interface bus

WEIGHTING NETWORKS:

Curves A, B, C are in accordance with IEC 651 (Type 0) for precision sound level meters. Curve D is in accordance with IEC 537

AVERAGING TIME PROGRAMMES:

Used with Measuring Amplifiers that feature remote controlled averaging times (Type 2636)
Programmes Available:
See Table 3 and Fig. 9

INPUT:

Via B&K coaxial socket on front panel, in parallel with a BNC socket on the rear panel
Impedance: 1M Ω || 100pF

Voltage:

1V RMS nominal
5V peak maximum
5.6V (\pm 0.3V) overload warning lamp lights

DISTORTION:

Band Pass Filters:

<0.1% with 1V signal level
<0.3% with 3.6V signal level
Linear Range:
<0.1% with 1V signal level
<0.3% with 3.6V signal level

NOISE:

<150 μ V (typ. 100) Band Pass Filters
<110 μ V (typ. 80) A, B, and C-weighting networks
<250 μ V (typ. 180) D-weighting network
<100 μ V (typ. 80) Linear range
See EMC Immunity, note 2

OUTPUT:

Via B&K coaxial socket on front panel, in parallel with a BNC socket on the rear panel

Impedance:

<50 Ω

Minimum Load Impedance:

5k Ω || 1nF for less than \pm 0.2% reading error

DC Ramp Output:

Used for controlling the X-axis of an X–Y Recorder
0V at the starting frequency
0.208V per 1/3 octave increase rate
10.4V maximum output
Load impedance >10k Ω

Specifications 1617 (cont.)

IEEE/IEC DIGITAL INTERFACE:

Conforms to IEC 625-1 standard, compatible with IEEE std. 488
 IEC Functions Implemented:
 Acceptor Handshake (AH1)
 Listener (L2)
 Remote Local (RL2)
 Parallel Poll (PP2)

POWER REQUIREMENTS:

Supply Voltage: 100; 115; 127; 200; 220; 240V (50-60Hz) ±10% AC
Power Consumption: ~37VA

CABINET:

Supplied as model A (light-weight metal cabinet), or C (as A but with Flanges for standard 19" rack mounting)

DIMENSIONS:

Height: 133mm (5.25in)
 Width: 430mm (16.9in)
 Depth: 200mm (7.9in)

WEIGHT:

6.5kg (14.3lb.)

COMPLIANCE WITH STANDARDS:

CE	CE-mark indicates compliance with: EMC Directive and Low Voltage Directive.
Safety	IEC 348: Safety requirements for electronic measuring apparatus
EMC Emission	EN 50081-1: Generic emission standard. Part 1: Residential, commercial and light industry. CISPR 22: Radio disturbance characteristics of information technology equipment. Class B Limits. FCC Rules, Part 15: Complies with the limits for a Class B digital device.
EMC Immunity	EN 50082-1: Generic immunity standard. Part 1: Residential, commercial and light industry. Note 1: The above is guaranteed using accessories listed in this Product Data sheet only. Note 2: Susceptibility to radiated RF (3 V/m, 80% AM): Input noise in all filter bands up to 2.3 mV
Temperature	IEC 68-2-1 & IEC 68-2-2: Environmental Testing. Cold and Dry Heat. Operating Temperature: 5 to 40 °C (41 to 104 °F) Storage Temperature: -25 to +70 °C (-13 to +158 °F)
Humidity	IEC 68-2-3: Damp Heat: 90% RH (non-condensing at 30 °C (86 °F))
Mechanical	Non-operating: IEC 68-2-6: Vibration: 0.3 mm, 20 m/s ² , 10-500 Hz IEC 68-2-27: Shock: 1000 m/s ² IEC 68-2-29: Bump: 1000 bumps at 250 m/s ²
Enclosure	IEC 529: Protection provided by enclosures: IP 20

Ordering Information

Type 1617: Band Pass Filter
Includes the following Accessories:
 JP0703: 7-pin DIN Plug
 JP0802: 8-pin DIN Plug
 2×VF0012: 200mA Fuses
 3×VF0039 400mA Fuses
 Power Cable

Accessories Available

AO0184: Interface Cable (2m), IEC (25-way male, slide lock) to IEC 625-1 (25-way)
AO0194: Interface Cable (2m), IEC 625-1 (25-way)

AO0195: Adaptor to convert IEEE-488 connector to IEC 625-1 (25-way)
AO0264: Interface Cable (2m), IEC 625-1 (25-way) to IEEE-488
AO0265: Interface Cable (2m), IEEE-488
AO0145: Averaging Time Control Cable

Brüel&Kjær reserves the right to change specifications and accessories without notice



WORLD HEADQUARTERS:

DK-2850 Naerum · Denmark · Telephone: +45 45 80 05 00 · Fax: +45 45 80 14 05 · Internet: <http://www.bk.dk> · e-mail: info@bk.dk
 Australia (02) 9450-2066 · Austria 00 43-1-865 74 00 · Belgium 016/44 92 25 · Brazil (011) 246-8166 · Canada: (514) 695-8225 · China 10 6841 9625 / 10 6843 7426
 Czech Republic 02-67 021100 · Finland 90-229 3021 · France (01) 69 90 69 00 · Germany 0610 3/908-5 · Holland (0)30 6039994 · Hong Kong 254 8 7486
 Hungary (1) 215 83 05 · Italy (02) 57 60 4141 · Japan 03-3779-8671 · Republic of Korea (02) 3473-0605 · Norway 66 90 4410 · Poland (0-22) 40 93 92 · Portugal (1) 47114 53
 Singapore (65) 275-8816 · Slovak Republic 07-37 6181 · Spain (91) 36810 00 · Sweden (08) 71127 30 · Switzerland 01/94 0 09 09 · Taiwan (02) 713 9303
 United Kingdom and Ireland (0181) 954-236 6 · USA 1 - 800 - 322 - 2040
 Local representatives and service organisations worldwide